

THE INFORMATION CONTAINED IN THIS DRAWING IS THE SOLE PROPERTY OF VTE INCORPORATED. ANY REPRODUCTION IN PART OR WHOLE WITHOUT THE WRITTEN PERMISSION OF VTE INCORPORATED IS PROHIBITED. VTE MAKES NO WARRANTY, EXPRESSED OR IMPLIED, AS TO THE SUITABILITY OF A PRODUCT FOR ANY INTENDED USE. THE CUSTOMER SHALL BEAR THE SOLE RESPONSIBILITY OF DETERMINING THE SUITABILITY OF ANY VTE PRODUCT FOR ITS END USE.

LTR.	REVISIONS	DATE	INT.
A	UPDATED TORQUE VALUES FROM 180 IN-LBS [20.34 Nm]	2-03-18	RAS
B	UPDATED DIMENSION OF 361N5 BASE	10-28-20	EJE

USE GREENLEE PUNCH
ASSEMBLY #60098
FOR PANEL CUTOUT

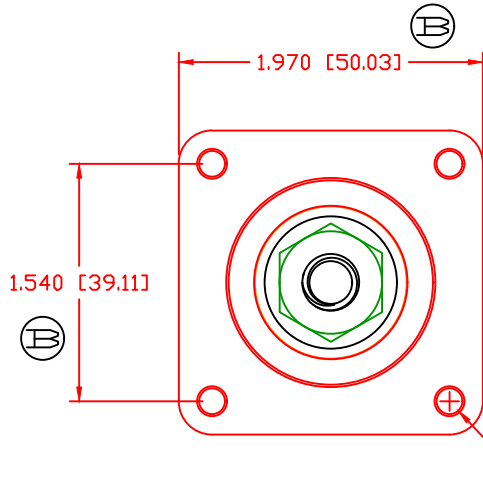
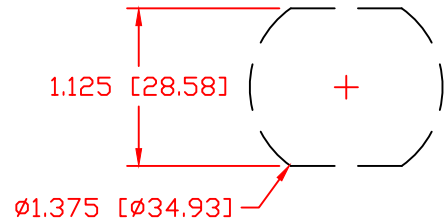

ASSEMBLY
CCFB376N02W
CONSIST OF :

- 1-CCFB376N02
POWER BUSHING
- 1-3960-002
SEALING GASKET
- 1-232N3V02
INSULATOR BOOT

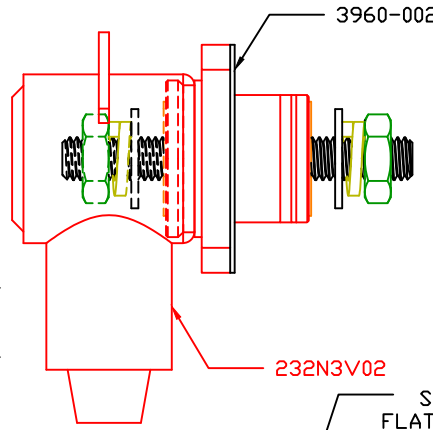

P/N 3960-002
.062 THICK CF 4480 81 DURDMETER
FIBERGLASS REINFORCED SILICONE
PRESS PAD SEALING GASKET

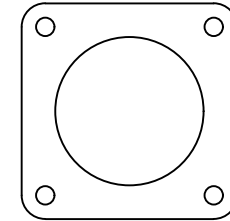

3844-012 3/8"-16
STAINLESS STEEL
JAM NUT (2) REQ'D

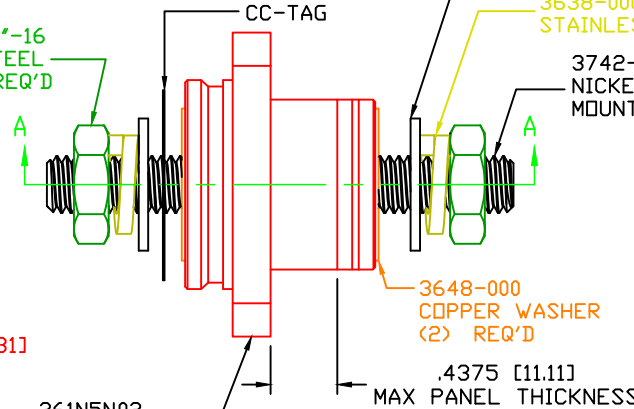

3646-000
STAINLESS STEEL
FLAT WASHER (2) REQ'D

3638-000 LOCK WASHER
STAINLESS STEEL (2) REQ'D

3742-007
NICKEL PLATED
MOUNTING STUD

3863-000
COPPER CORE

3648-000
COPPER WASHER
(2) REQ'D

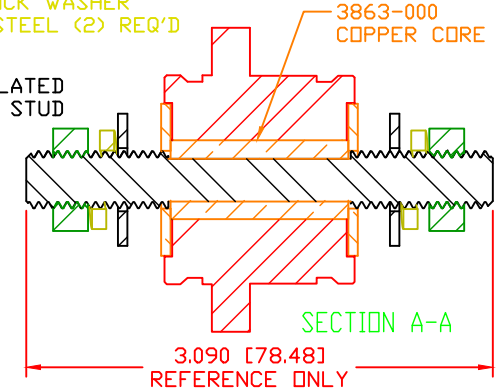

361N5N02
GLASS FILLED
NYLON BUSHING

.4375 [11.11]
MAX PANEL THICKNESS

SCALE FACTOR : NONE
ALL DIMENSIONS GIVEN AS: in [mm]
TOLERANCES UNLESS OTHERWISE SPECIFIED :
MOLDED PARTS: ±.030" [±0.8mm]
HARDWARE ITEMS: ±.010" [±0.25mm]

⊕ MAXIMUM FASTENER TORQUES:
JAM NUTS: 212 IN-LBS [24.0 Nm]

CURRENT CARRYING CAPACITY:
DUTY CYCLE:
CURRENT CAPACITY:
TEMPORARY MAX (12 MINUTES)

80%
5.2 Kw (440 AMP @ 12VDC)
6.6 Kw (550 AMP @ 12VDC)

MATERIAL PART NO:
MATERIAL:
VENDOR PART NO:
SPECIFIC GRAVITY:
MELTING TEMP:
U.L. RATING:

7111210502
GLASS FILLED NYLON
NYLON N2015 HL NAT
1.23
515 F [268 C]
UL 94 HB



VTE Incorporated
5437 Robinson Road, P.O. Box 790
Pellston, Michigan 49769
Telephone: 1-800-527-9256, 231-539-8000
FAX: 231-539-0914

REF: CUSTOMER DIMS	DATE: 11-16-17	DRN BY: RAS	WEIGHT:
		CHK'D BY: PJK	
TITLE: 3/8" PANEL MOUNT POWER BUSHING, COPPER CORE			
MATERIAL: GLASS FILLED NYLON		PART NO. CCFB376N02W	
COLOR: RED	DRG CLASS	REV B	