

THE INFORMATION CONTAINED IN THIS DRAWING IS THE SOLE PROPERTY OF VTE INCORPORATED. ANY REPRODUCTION IN PART OR WHOLE WITHOUT THE WRITTEN PERMISSION OF VTE INCORPORATED IS PROHIBITED. VTE MAKES NO WARRANTY, EXPRESSED OR IMPLIED, AS TO THE SUITABILITY OF A PRODUCT FOR ANY INTENDED USE. THE CUSTOMER SHALL BEAR THE SOLE RESPONSIBILITY OF DETERMINING THE SUITABILITY OF ANY VTE PRODUCT FOR ITS END USE.

LTR.	REVISIONS	DATE	INT.

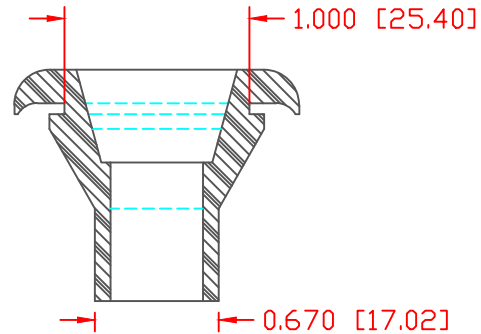
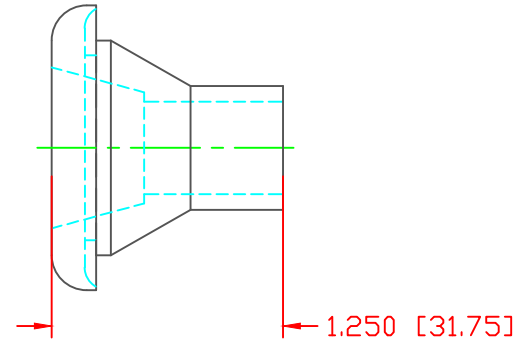
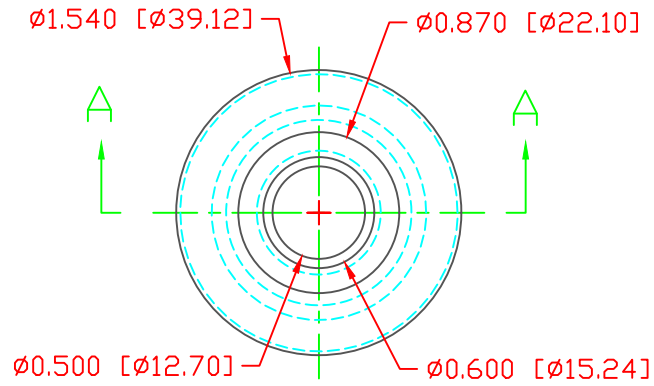

SECTION A-A

SCALE FACTOR : NONE  
 ALL DIMENSIONS GIVEN AS: in [mm]  
 TOLERANCES UNLESS OTHERWISE SPECIFIED :  
 MOLDED PARTS: ±.030" [±0.8mm]  
 ALL ANGLES ARE ± 1 DEGREE

VTE PART NO:	1101650113
MATERIAL:	PVC
VENDOR PART NO:	9812-65-GRAY 9558
SHORE DUREMETER:	"A" 10 SEC. 65
SPECIFIC GRAVITY:	1.34
ULT. ELONGATION %:	400
MELTING TEMP:	315-335 F [157-168 C]
BRITTLE TEMP:	-54 F [-48 C]
Tensile Strength PSI:	1550 PSI
Dielectric Strength, v./mil	495
U.L. Rating:	V2

DO NOT SCALE

		<b>VTE Incorporated</b> 5437 Robinson Road, P.O. Box 790 Pellston, Michigan 49769 Telephone: 1-800-527-9256, 231-539-8000 FAX: 231-539-0914	
		REF:	DATE:
CUSTOMER DIMS	03-25-98	CHK'D BY: JC	.027 LBS [12.6 g]
TITLE: GROMMET, WIRING 1" DIAMETER HOLE			
MATERIAL: PVC		PART NO.	
COLOR: GREY		310N9V13	
DRG CLASS			